

CAT 6A HD Module Connector

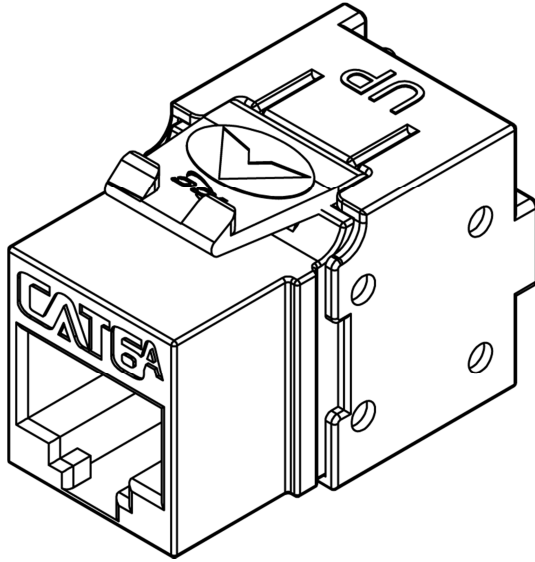

Package Includes:

- A. HD CAT 6A Module, **1 Piece**
- B. Wiring Cap, **1 Piece**

Features and Benefits

- CAT 6A rated connectors provide excellent performance for data networks requiring maximum speed and bandwidth.
- PCB technology provides maximum performance and superior signal quality.
- Enhanced crosstalk cancellation reduces return loss and improves performance by rejecting noise and unwanted signals.
- Exceeds ANSI/TIA-568-C requirements for permanent, channel link and component performances.
- Engineered to provide 110 IDC termination reducing installation time
- Includes an integrated TIA-568A/B color wiring diagram
- Backwards compatible to all lower rated category components
- Compatible with IC107 faceplates, inserts, surface mount boxes, and blank patch panels
- Used with JackEasy™ Termination Tool ICACSPDTEH, and 110 punch down tool ICACSPDT00
- Available in black, blue, ivory, orange, red, and white
- UL 1863 compliant
- Country Of Origin: Taiwan
- TAA Compliant

Note:

Check faceplates, inserts, surface mount boxes, bezel, or blank patch panel part for compatibility

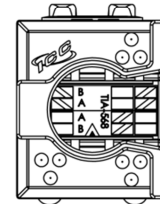
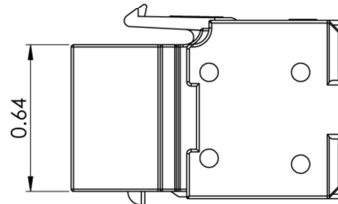
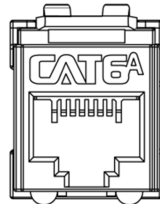
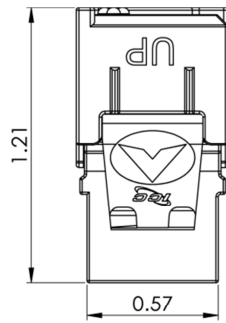

NOTE: UNLESS OTHERWISE SPECIFIED

1. Certification:

A. Meets ANSI/TIA-568-C.2 (500MHz)

2. Environmental Condition:

A. Storage: -40 To +70°C

B. Operation: -10 To +60°C

CAT 6A Connecting Hardware Requirements															
Frequency	1.0	4.0	8.0	10.	16.	20.	25.	31.	62.	100	200	250	300	400	500
NEXT Loss	75.	75.	75.	74.	69.	68.	66.	64.	58.	54.	48.	46.	42.	37.	34.
FEXT Loss	75.	71.	65.	63.	59.	57.	55.	53.	47.	43.	37.	35.	33.	31.	29.
RETURN	35.	30.	30.	30.	30.	30.	30.	30.	30.	28.	22.	20.	18.	16.	14.

3. Electrical:

A. Electrical Insulation Resistance: 500 MΩ Min @ 100V DC

B. Dielectric Withstanding Voltage: 1000V DC or AC Peak Contact To Contact @ 60Hz For 1 Minute

C. Spring Wire Contact Resistance: 20 MΩ Max

D. IDC Contact Resistance: 2.5 MΩ Max

4. Mechanical:

A. Retention: 50N (11 LBF) For 60s +/-5s

B. Insertion/Extraction Life: 750 Cycles Min.

5. CAT 6A Module:

A. Material:

-Housing: High Impact, Flame Retardant Plastic, UL 94V-0

-Jack Wiring: Phosphor Bronze Alloy Plated with 50 μin of Gold over 70~100 μin of Nickel

-Connector: Insulation Displacement Connector (IDC)

Accepts 22~24 AWG Solid Wire

D. Colors: XX: BK-Black, BL-Blue, IV-Ivory, OR-Orange, RD-Red, & WH-White

WIRING DIAGRAM

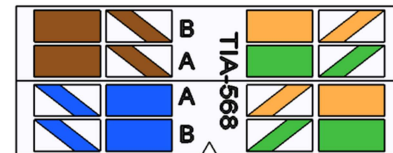

2. Shielded Wire Cap:

A. Material: High-Impact, Flame Retardant Plastic, UL 94V-0

B. Color: Black

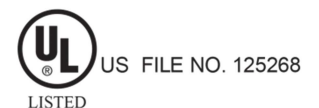

Part No: IC1078GAXX

Rev: D

Page 2 of 2

| 888-ASK-4ICC | icc.com | csr@icc.com |

