

# CAT 5e HD Modular Connector, 400 Pack, w/ JackEasy™

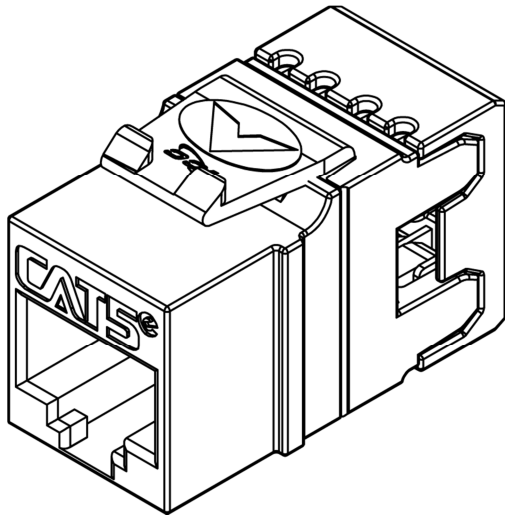

## Package Includes:

- A. CAT 5e HD Module, **400 Pieces**
- B. JackEasy™ Termination Tool, **1 Piece**
- C. Installation Instructions, **1 sheet**

## Features and Benefits

- CAT 5e rated connectors provide excellent performance for data networks requiring maximum speed and bandwidth.
- PCB technology provides maximum performance and superior signal quality.
- Enhanced crosstalk cancellation reduces return loss and improves performance by rejecting noise and unwanted signals.
- Exceeds ANSI/TIA-568-C requirements for permanent, channel link and component Performances.
- Engineered to provide 110 IDC termination reducing installation time
- Reduced rear footprint allows for greater connectivity density and provides for more port configurations in smaller area
- Includes an integrated TIA-568A/B color wiring diagram
- Backwards compatible to all lower rated category components
- Compatible with all IC107 faceplates, inserts, surface mount boxes, and blank patch panels
- Used with ICC Category 5e ICPCSK series patch cords, JackEasy™ Termination Tool ICACSPDTEH, and 110 punch down tool ICACSPDT00
- JackEasy™ Termination Tool is included for convenience-- ICACSPDTEH
- Available in Blue and White
- UL 1863 compliant
- Country Of Origin: Taiwan
- TAA Compliant

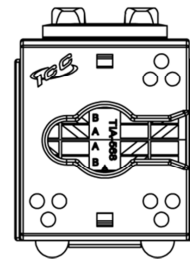
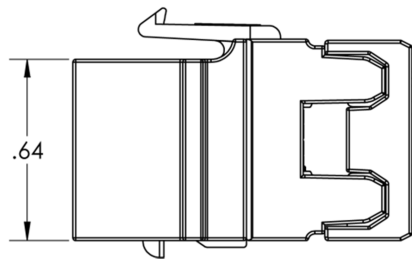
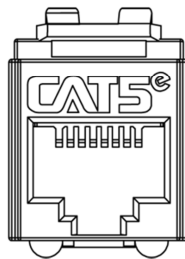
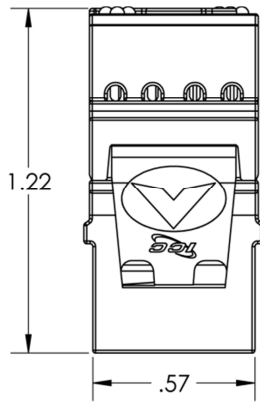

**NOTE: UNLESS OTHERWISE SPECIFIED**

1. CAT 5e Module:

A. Electrical:

- Current Rating: 1.5 AMPS
- Insulation Resistance: 500 MOHMS Min
- Contact Resistance: 20 MOHMS Max
- DC Resistance: 0.1 OHM Max

CAT 5e Connecting Hardware Requirements										
Frequency (MHz)	1.0	4.0	8.0	10.0	16.0	20.0	25.0	31.25	62.5	100
NEXT Loss (dB)	65.0	65.0	64.9	63.0	58.9	57.0	55.0	53.1	47.1	43.0
FEXT Loss (dB)	75.1	63.1	57.0	55.1	51.0	49.1	47.1	45.2	39.2	35.1
RETURN Loss (dB)	35.0	35.0	35.0	35.0	35.0	34.0	32.0	30.1	24.1	20.0
Insertion Loss (dB)	0.10	0.10	0.10	0.10	0.20	0.20	0.20	0.20	0.30	0.40

B. Mechanical:

- Plug Insertion Life: 750 Cycles Min
- Plug & Jack Contact Force: 100 Grams Min  
Using FCC approved plug
- Plug Retention Force: 50N (11 LBS) for 60s ± 5s
- Temperature: -40° to 150°F (-40° to 68°C)

C. Physicals:

- Housing: High Impact, Flame Retardant Plastic, UL 94V-0
- Jack Wiring: Phosphor Bronze Alloy Plated with 50 µin of Gold  
over 70~100 µin of Nickel
- Connector: Insulation Displacement Connector (IDC)  
Accepts 22~24 AWG Solid Wire

D. Colors: XX: BL-Blue & WH-White

**WIRING DIAGRAM**

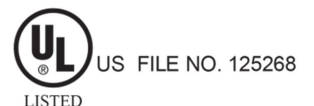
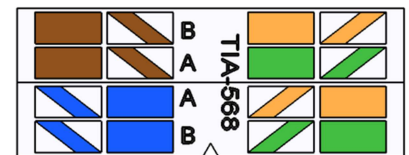

Part No: IC107F5VXX  
Rev: B  
Page 3 of 2

| 888-ASK-4ICC | [icc.com](http://icc.com) | [csr@icc.com](mailto:csr@icc.com) |

