

# Clear Dust Cover Insert

## PRODUCT SPECIFICATION

### Package includes:

A. Dust Cover Insert, 10 pcs

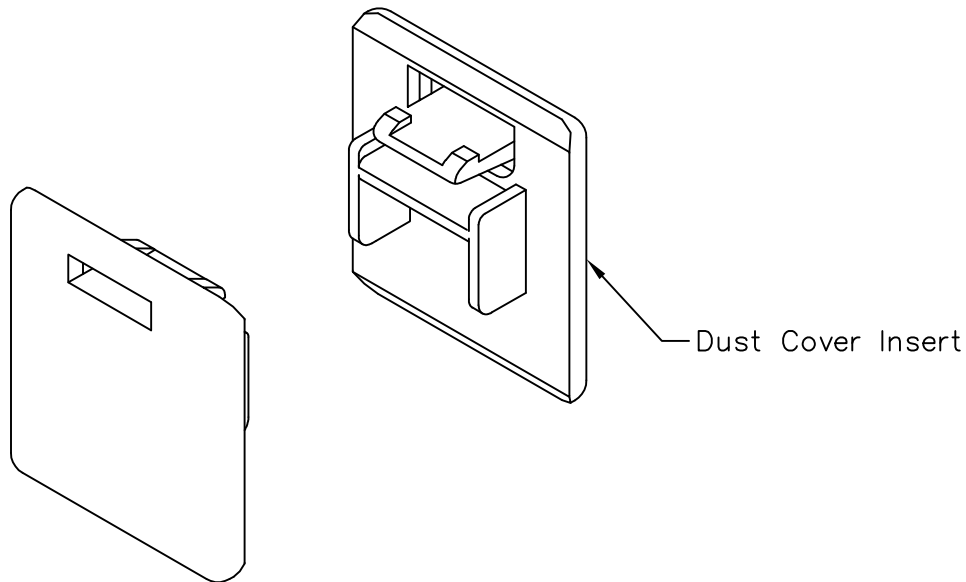

### Features and Benefits:

- Fills unused modules and ports to prevent dust and debris
- Used with ICC's CAT 5e, CAT 6, CAT 6A, voice modules, couplers, faceplates, inserts, and patch panels
- Available in clear
- ANSI/TIA-568-C and UL 1863 compliant

### DUST COVER INSERT, CLEAR, 10 PK

ITEM NO. ICACSDCICL  
DWG NO. PSACSDCICL

REV. A  
PAGE NO. 1



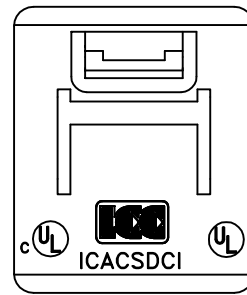
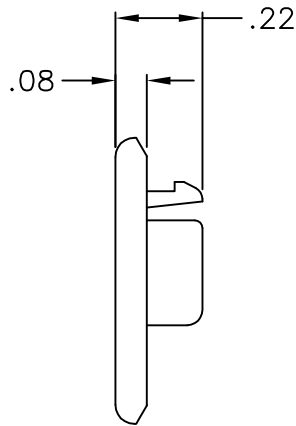
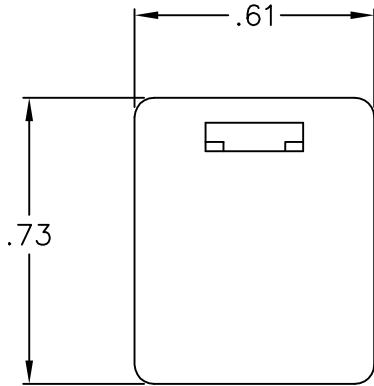
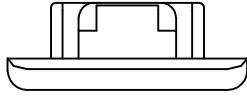

CUSTOMER CARE / TECHNICAL SUPPORT \* CSR@ICC.COM / 888-ASK-4-ICC (275-4422) \* 2100 East Valencia Drive, Suite D, Fullerton, CA 92831 \* www.icc.com



**NOTE: UNLESS OTHERWISE SPECIFIED**

1. MATERIAL: ABS, UL 94V-0
2. COLOR: CLEAR
3. SURFACE FINISHING: TEXTURE

c  US FILE NO. 125268

<b>DUST COVER INSERT, CLEAR, 10 PK</b>		 <i>PremiumProducts</i> <i>ProvenPerformance</i> <i>CompetitivePrices</i>	
ITEM NO.	ICACSDCICL		REV. A
DWG NO.	PSACSDCICL		PAGE NO. 2

CUSTOMER CARE / TECHNICAL SUPPORT \* CSR@ICC.COM / 888-ASK-4-ICC (275-4422) \* 2100 East Valencia Drive, Suite D, Fullerton, CA 92831 \* www.icc.com