

Category 5e 8P8C RJ-45 Plug (Stranded Wires)

PRODUCT SPECIFICATION

Package includes:

- A. CAT 5e 8P8C Plug, 100 pcs
- B. Loading Bar, 100 pcs

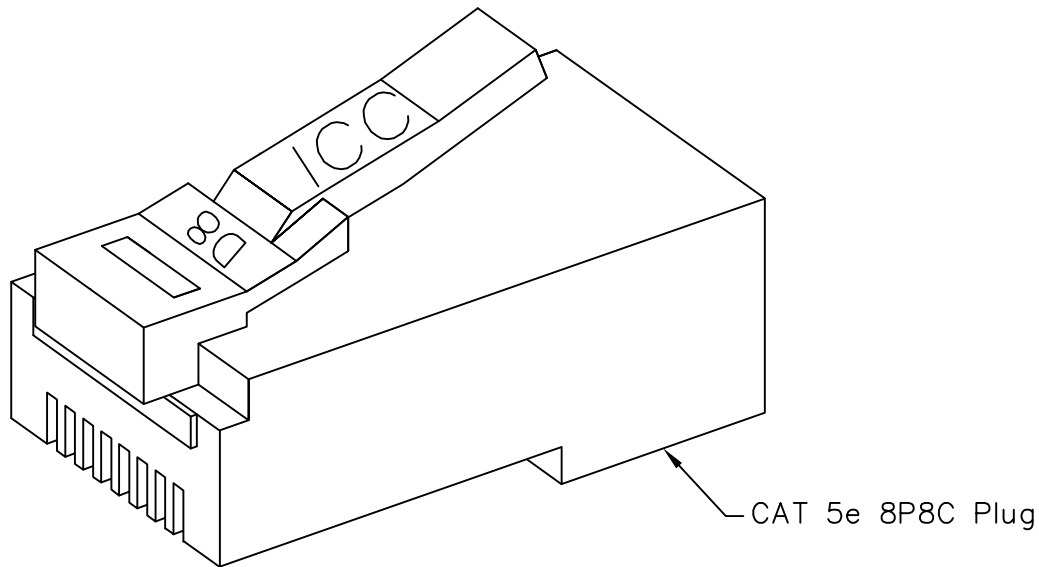

Features and Benefits:

- Designed for 8-position 8-conductor, stranded wires, round CAT 5e UPT cables
- Loading bar allows for enhanced performance and easily
- Ideal for customization of patch cords for voice or data applications
- Meets ANSI/TIA/EIA-568-B.2 Category 5e requirements
- Accepts 26~24 AWG stranded wires
- Used with ICACSCT845 and ICACSCT864 crimping tools.
- UL recognized

PLUG, 8P8C, CAT 5E, STRANDED, 100 PK

ITEM NO.	ICMP8P8C5E
DWG NO.	PSMP8P8C5E

REV.	B
PAGE NO.	1



CUSTOMER CARE / TECHNICAL SUPPORT * CSR@ICC.COM / 888-ASK-4-ICC (275-4422) * 14700 Alondra Blvd., La Mirada, CA 90638 * www.icc.com

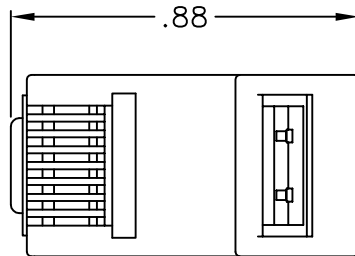
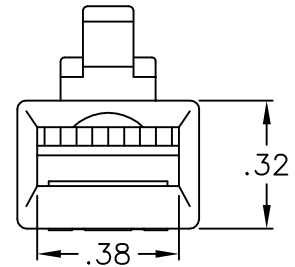
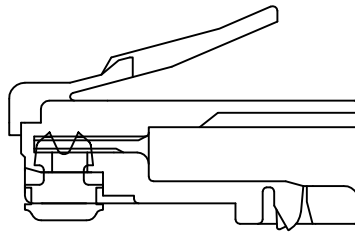
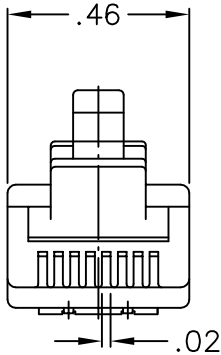
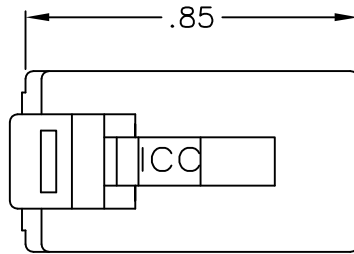

LOADING BAR

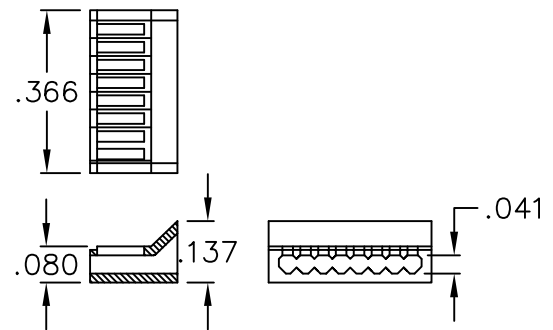

NOTE: UNLESS OTHERWISE SPECIFIED

1. ELECTRICAL:

- A. UL APPLICATIONS: RATED 2A, 150V
- B. DIELECTRIC WITHSTANDING VOLTAGE: 500 VOLTS AC
- C. INSULATION RESISTANCE: 500 MOHMS
- D. TERMINATION RESISTANCE: 35 MILLIOHMS MAX AFTER ENVIRONMENTAL TESTING

2. MECHANICAL:

- A. CABLE-TO-PLUG TENSILE STRENGTH: 20 LBS [89N] MIN
- B. DURABILITY: 200 MATING CYCLES

3. MATERIAL & FINISH:

- A. HOUSING: PC, UL 94V-0
- B. COLOR: CLEAR
- C. CONTACT: HIGH STRENGTH COPPER ALLOY, GOLD PLATING OVER 100 MICRO INCH NICKEL
- D. GOLD PLATING: 1.27 MICRON/50 MICRO INCH MIN
- E. CONDUCTOR: 24 AND 26 AWG STRANDED

PLUG, 8P8C, CAT 5E, STRANDED, 100 PK			
ITEM NO.	ICMP8P8C5E		REV. B
DWG NO.	PSMP8P8C5E		PAGE NO. 2

CUSTOMER CARE / TECHNICAL SUPPORT * CSR@ICC.COM / 888-ASK-4-ICC (275-4422) * 14700 Alondra Blvd., La Mirada, CA 90638 * www.icc.com