

# 3/4" Outside Corner Cover & Base

## PRODUCT SPECIFICATION

### Package includes:

- A. 3/4" Outside Corner Cover, 10 pcs
- B. 3/4" Outside Corner Base, 10 pcs

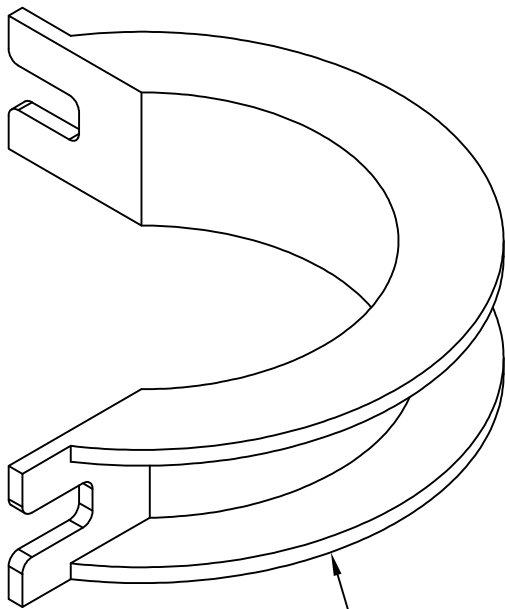

10X 3/4" Outside  
Corner Base

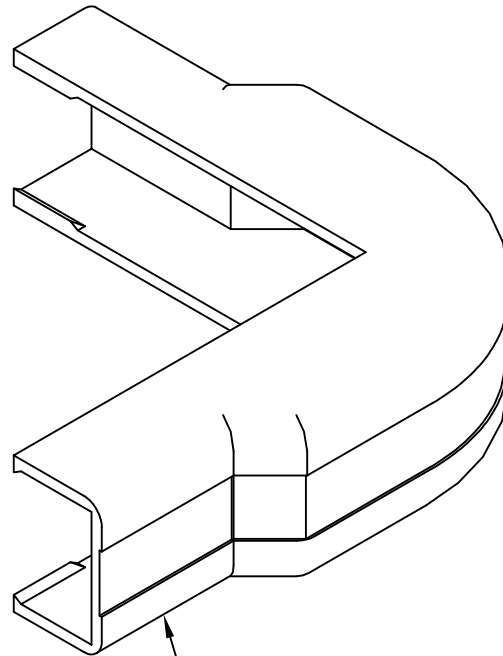

10X 3/4" Outside  
Corner Cover

### Features and Benefits:

- Designed to maintain cable bend radius
- Accommodates ICRW22R, ICRWR118, and ICRWR11S 3/4"W x 1/2"H raceway sections
- Available in ivory and white

### OUTSIDE CORNER & BASE, 3/4", 10 PK

ITEM NO.	ICRW110BXX
DWG NO.	PSRW110B00

REV.	A
PAGE NO.	1



CUSTOMER CARE / TECHNICAL SUPPORT \* CSR@ICC.COM / 888-ASK-4-ICC (275-4422) \* 2100 E. Valencia Dr, Suite D, Fullerton, CA 92831 \* www.icc.com

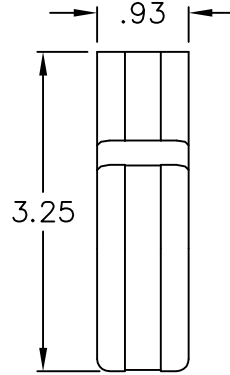
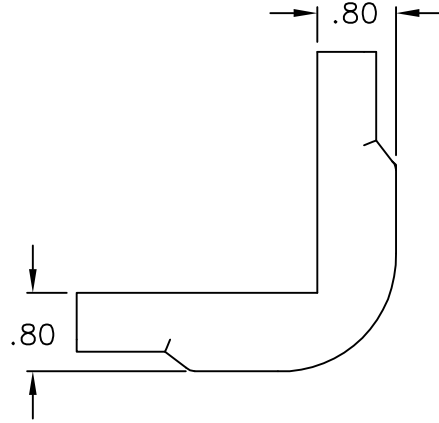
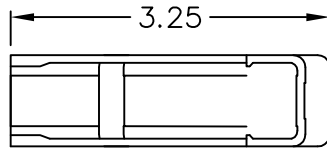

**3/4" OUTSIDE CORNER COVER**

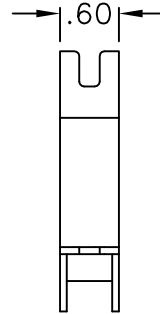
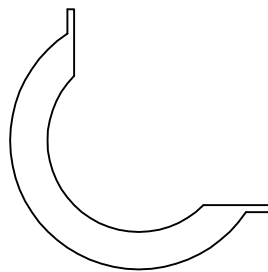

**3/4" OUTSIDE CORNER BASE**

**NOTE: UNLESS OTHERWISE SPECIFIED**

**1. MATERIAL:**

A. OUTSIDE CORNER COVER: HIGH IMPACT STYRENE

B. OUTSIDE CORNER BASE: HIGH IMPACT STYRENE

**2. COLOR: XX: IV-IVORY & WH-WHITE**

<b>OUTSIDE CORNER &amp; BASE, 3/4", 10 PK</b>			
ITEM NO.	ICRW110BXX		REV. A
DWG NO.	PSRW110B00		PAGE NO. 2

CUSTOMER CARE / TECHNICAL SUPPORT \* CSR@ICC.COM / 888-ASK-4-ICC (275-4422) \* 2100 E. Valencia Dr, Suite D, Fullerton, CA 92831 \* www.icc.com