

8P4C Keyed Surface Mount Jack With Shorting Bar

PRODUCT SPECIFICATION

Package includes:

- A. Surface Mount Jack Cover, 1 pc
- B. Surface Mount Jack Base, 1 pc
- C. Double Sided Adhesive Pad, 1 pc
- E. #6 x 3/4" Pan Head, Sharp Point Tapping Screw, 2 pcs

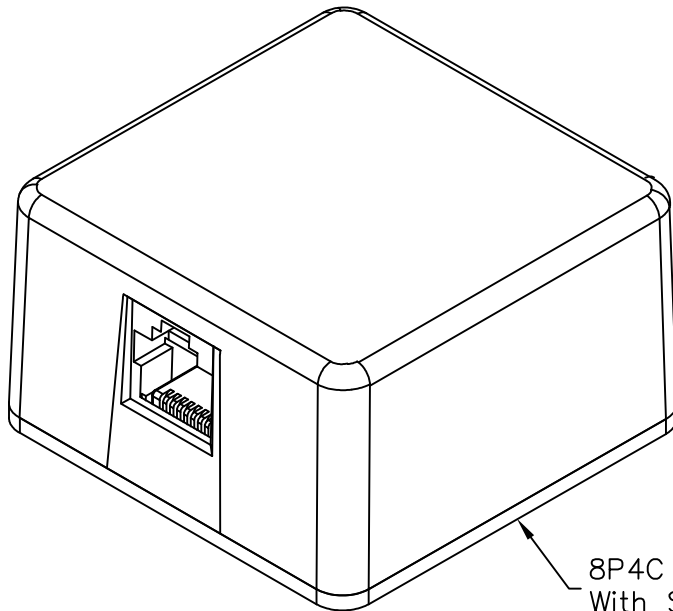

8P4C Keyed Surface Mount Jack
With Shorting Bar

Features and Benefits:

- Provides a clean modular surface mount outlet solution for voice connectivity applications
- Designed to support a multitude of high tech communication needs for residential or commercial applications
- Keyed RJ31X jack with shorting bar allows the alarm/security system to over ride line one
- Provided with traditional screw down terminals
- Multiple mounting options including adhesive backing and screws
- Rugged and durable construction
- Available in ivory and white
- ANSI/TIA-568-C and UL 1863 compliant

SURFACE MOUNT JACK, KEYED, 8P4C

ITEM NO.	IC635DS4XX
DWG NO.	PS635DS400

REV.	A
PAGE NO.	1



CUSTOMER CARE / TECHNICAL SUPPORT * CSR@ICC.COM / 888-ASK-4-ICC (275-4422) * 2100 E. Valencia Dr, Suite D, Fullerton, CA 92831 * www.icc.com

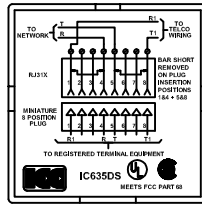
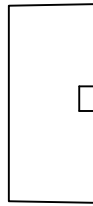
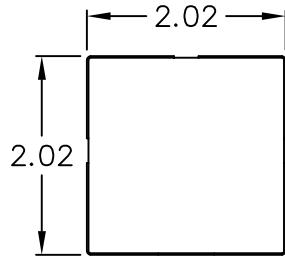

WIRING DIAGRAM:

POSITION	WIRE COLOR
1	BLUE
2	
3	
4	RED
5	GREEN
6	
7	
8	GRAY

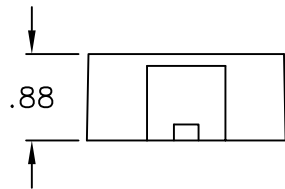

COVER

SHORTING BAR ON PINS
1 & 4 AND 5 & 8

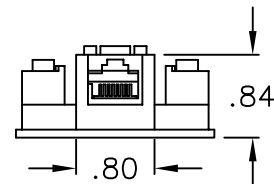
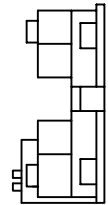
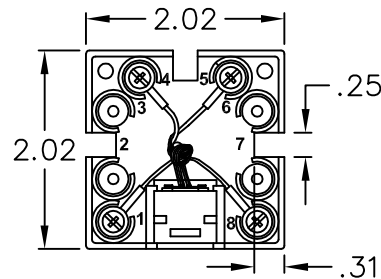
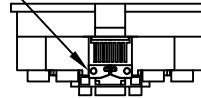

BASE

NOTE: UNLESS OTHERWISE SPECIFIED

1. MATERIAL:

- A. SURFACE MOUNT JACK HOUSING: ABS, UL94V-0
- B. SPRING WIRE CONTACTS: PHOSPHOR BRONZE GOLD PLATING
OVER 100 MICRO INCH NICKEL
- C. GOLD PLATING: 1.27 MICRON/50 MICRO INCH MIN
- D. WIRE LEADS: 26 AWG STRANDED WIRE
- E. TERMINATION SCREWS: 15 LBS/INCH MIN TORQUE
ZINC CHROMATIC PLATED STEEL
- F. TERMINAL LUGS: BRASS

2. COLOR: XX: IV-IVORY & WH-WHITE

3. MECHANICAL:

- A. TOTAL MATING FORCE: 500 GRAMS
- B. RETENTION: 17 LBS BETWEEN JACK AND PLUG
- C. CRIMP TENSILE STRENGTH: 4.0-500 LBS

4. ELECTRICAL:

- A. CURRENT RATING: 1.5 AMP MAX
- B. DIELECTRIC WITHSTANDING VOLTAGE: 1,000 VOLTS RMS, 60 HZ
- C. CONTACT RESISTANCE < 20 MILLIOHMS
- D. INSULATION RESISTANCE > 10 MEGAOHMS

UL US FILE NO. 125268

SURFACE MOUNT JACK, KEYED, 8P4C

ITEM NO. IC635DS4XX
DWG NO. PS635DS400

REV. A
PAGE NO. 2



CUSTOMER CARE / TECHNICAL SUPPORT * CSR@ICC.COM / 888-ASK-4-ICC (275-4422) * 2100 E. Valencia Dr, Suite D, Fullerton, CA 92831 * www.icc.com