

4-Port Single Gang Bottom Angled Faceplate

PRODUCT SPECIFICATION

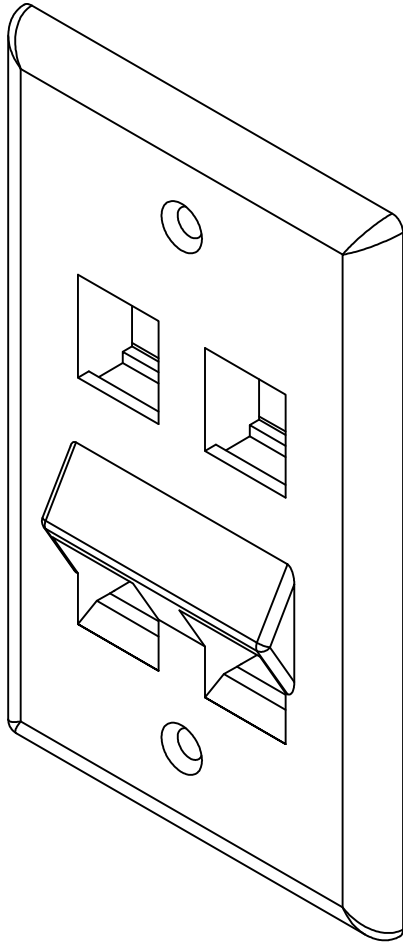

Package includes:

- A. 4-Port Single Gang Bottom Angled Faceplate, 1 pc
- B. #6-32 x 3/4" Oval Head, Countersink Machine Screw, 2 pcs

4-Port Bottom Angled Faceplate

Features and Benefits:

- Configured to fit standard single gang outlet box
- Designed to support the distribution of voice, data, and other communication needs to the work area for commercial or residential applications
- Rugged and durable construction
- Angled opening provides for a low profile and strain relief
- Accommodates a wide variety of easy to snap-in modules, providing configuration flexibility
- Accepts all IC107 modules
- Available in ivory and white
- ANSI/TIA-568-C and UL 1863 compliant

FACEPLATE, BOTTOM ANGLED, 1-GANG, 4-PORT

ITEM NO.	IC107AF4XX
DWG NO.	PS107AF400

REV.	A
PAGE NO.	1



CUSTOMER CARE / TECHNICAL SUPPORT * CSR@ICC.COM / 888-ASK-4-ICC (275-4422) * 2100 E. Valencia Dr, Suite D, Fullerton, CA 92831 * www.icc.com

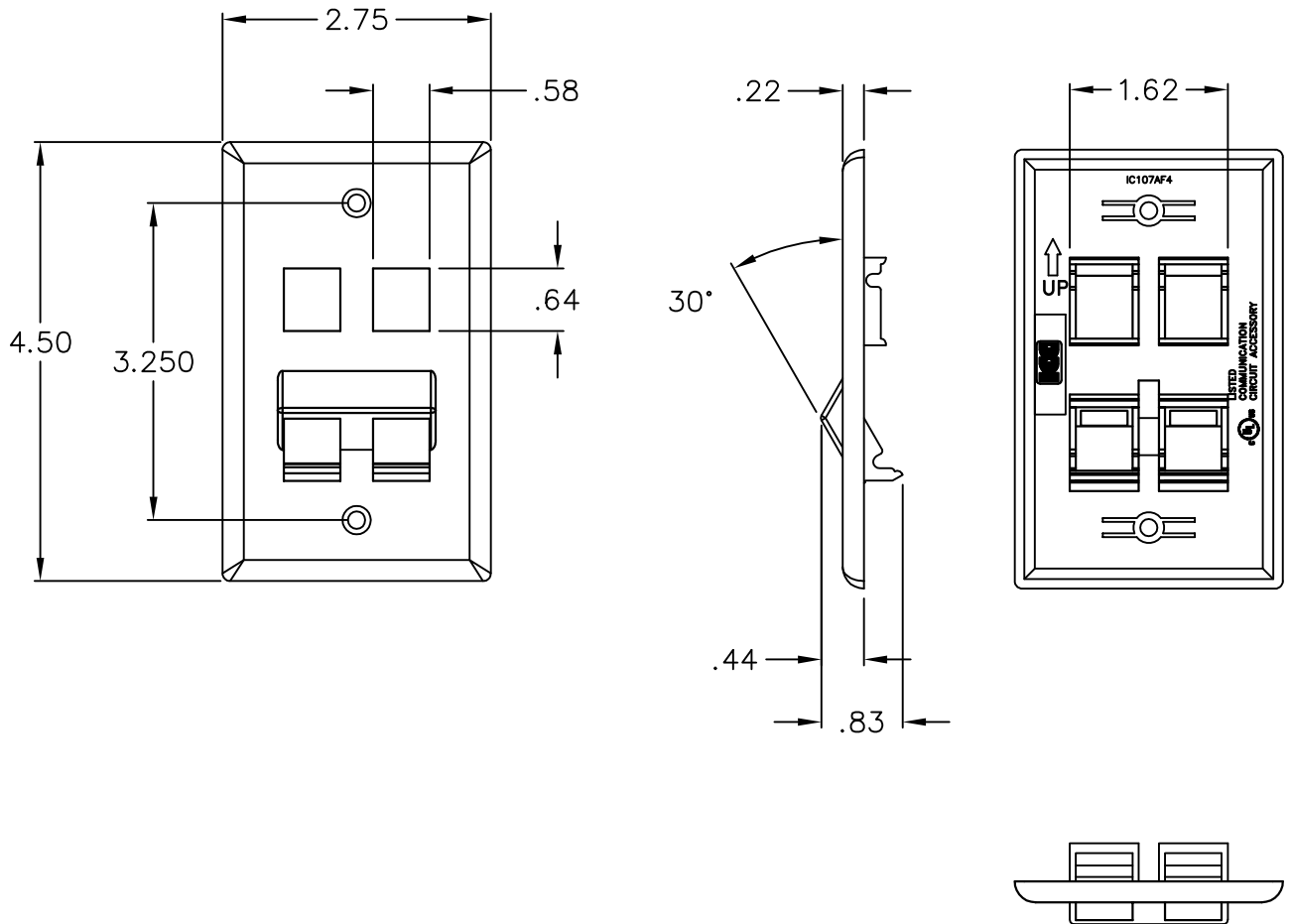

NOTE: UNLESS OTHERWISE SPECIFIED

- 1. MATERIAL: ABS, UL 94V-0
- 2. FINISH: TEXTURE
- 3. COLOR: XX: IV-IVORY & WH-WHITE

UL US FILE NO. 125268

FACEPLATE, BOTTOM ANGLED, 1-GANG, 4-PORT		
ITEM NO.	IC107AF4XX	
DWG NO.	PS107AF400	PAGE NO. 2

CUSTOMER CARE / TECHNICAL SUPPORT * CSR@ICC.COM / 888-ASK-4-ICC (275-4422) * 2100 E. Valencia Dr, Suite D, Fullerton, CA 92831 * www.icc.com