

# 1 3/4" to 1 1/4" Reducer

## PRODUCT SPECIFICATION

### Package includes:

A. 1 3/4" to 1 1/4" Reducerr, 10 pcs

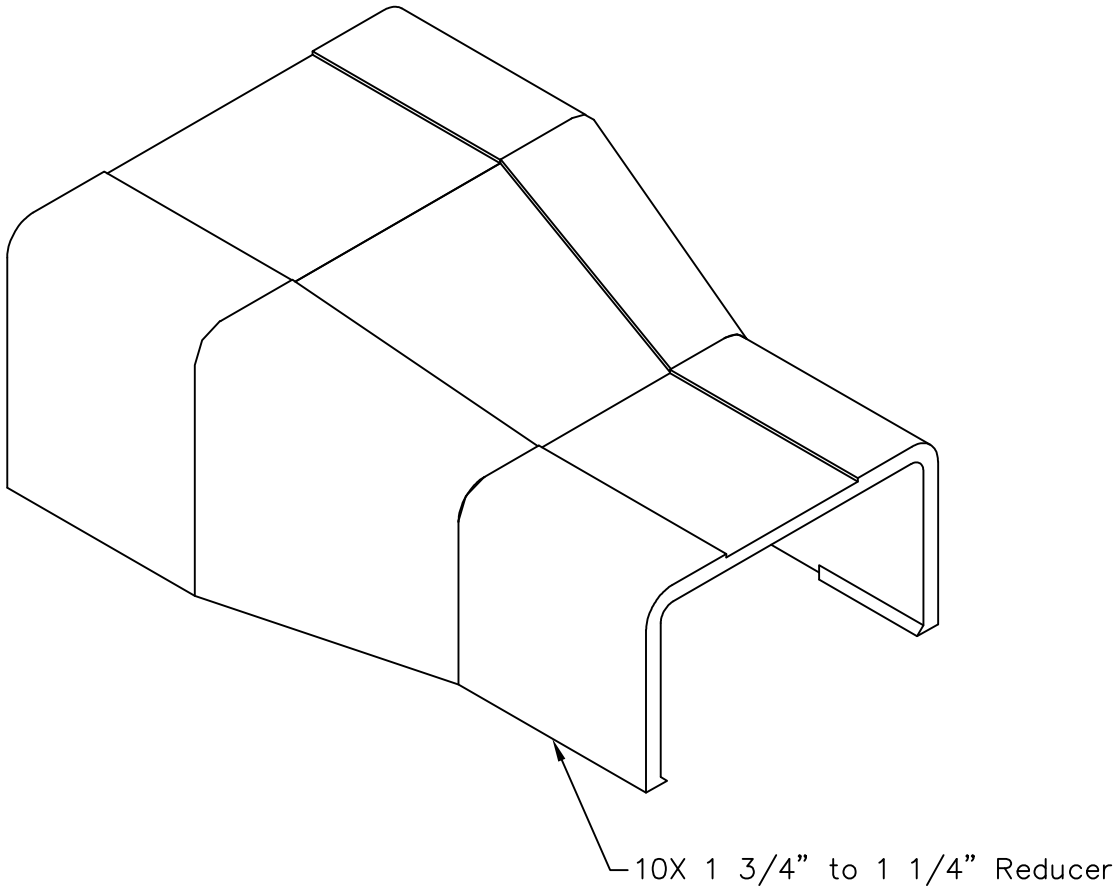

### Features and Benefits:

- Designed to connect smaller raceway sections to larger raceway sections or vice versa
- Accommodates ICRWR12 1 1/4"W x 3/4"H raceway sections and ICRWR13 1 3/4"W x 1"H raceway sections
- Available in ivory and white

<b>REDUCER, 1 3/4" TO 1 1/4", 10 PK</b>		 <i>PremiumProducts</i> <i>ProvenPerformance</i> <i>CompetitivePrices</i>	
ITEM NO.	ICRW13ROXX		REV. A
DWG NO.	PSRW13R000		PAGE NO. 1

CUSTOMER CARE / TECHNICAL SUPPORT \* CSR@ICC.COM / 888-ASK-4-ICC (275-4422) \* 2100 E. Valencia Dr, Suite D, Fullerton, CA 92831 \* www.icc.com

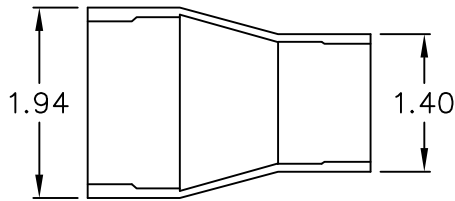
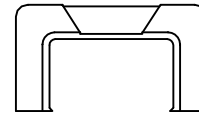
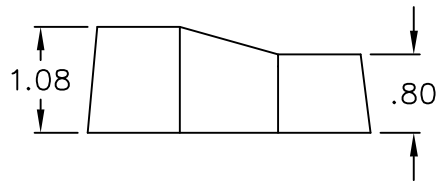
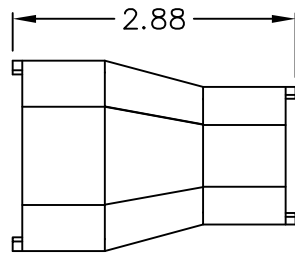

**NOTE: UNLESS OTHERWISE SPECIFIED**

1. MATERIAL: HIGH IMPACT STYRENE
2. COLOR: XX: IV-IVORY & WH-WHITE

<b>REDUCER, 1 3/4" TO 1 1/4", 10 PK</b>		 <i>PremiumProducts</i> <i>ProvenPerformance</i> <i>CompetitivePrices</i>	
ITEM NO.	ICRW13ROXX		REV. A
DWG NO.	PSRW13R000		PAGE NO. 2

CUSTOMER CARE / TECHNICAL SUPPORT \* CSR@ICC.COM / 888-ASK-4-ICC (275-4422) \* 2100 E. Valencia Dr, Suite D, Fullerton, CA 92831 \* www.icc.com