



14" Net Media Center Door Trim

INSTALLATION INSTRUCTIONS

Step 1. Slightly fasten (4) side mounting screws. Do not tighten.

Step 2. Mount trim onto Enclosure (see image below)

Step 3. Fasten top and bottom center mounting screws

Step 4. Mount door and fasten (4) side mounting screws

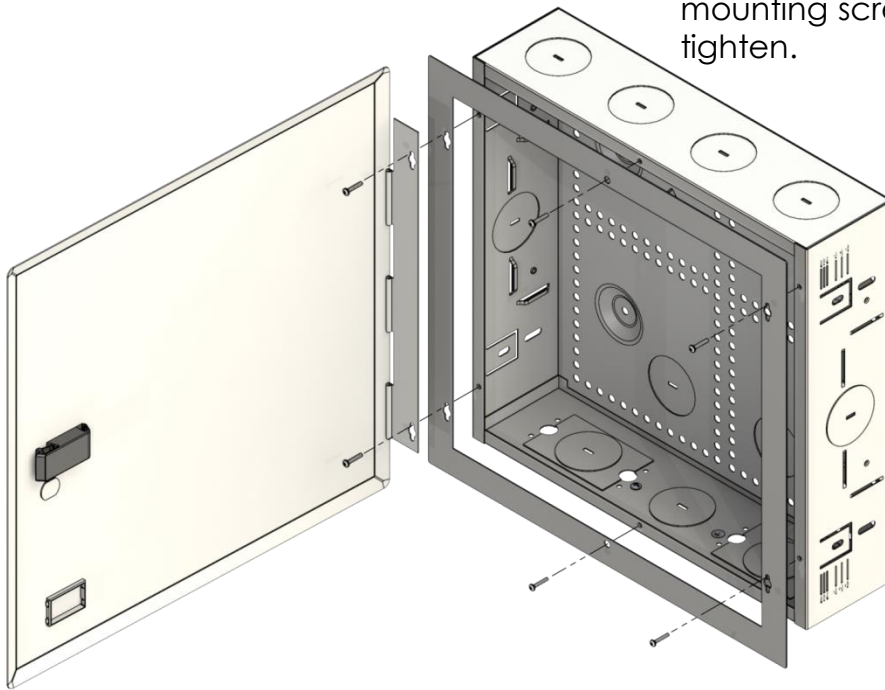

Arrow is pointed up when mounted to wall.

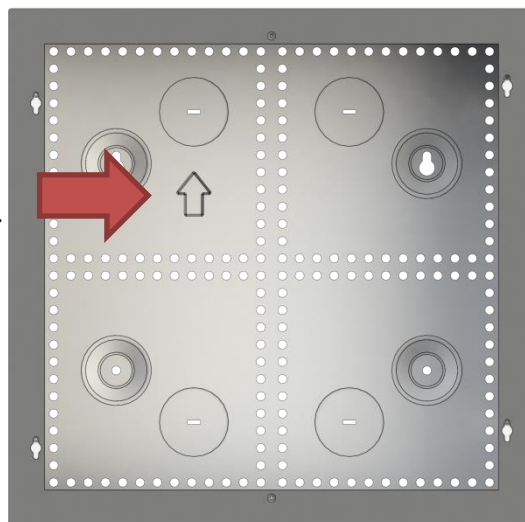

Mounting hole on the right side is higher than the Left side.

888-ASK-4ICC

csr@icc.com

icc.com

14" Net Media Center Door Trim

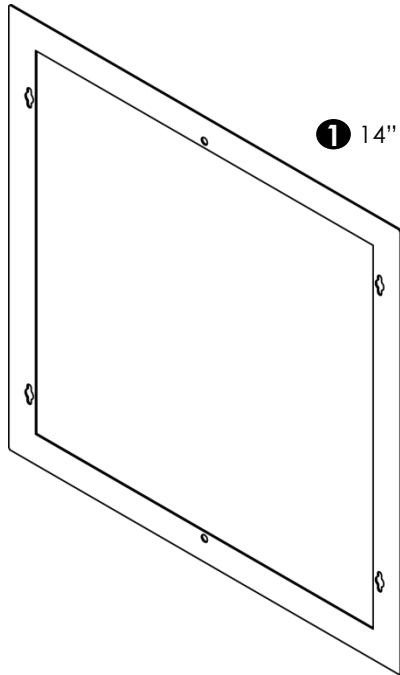

① 14" Net Media Center Door Trim 20 PCS

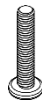

② M3 x 16mm Philip Rounded Head Screw 120 PCS

FEATURES & BENEFITS

- Designed with steel construction white powder coated, lightweight and sturdy
- Quick and easy installation
- Designed to cover uneven and oversized drywall cuts
- Used with ICRESDC14x 14" Net Media Center Enclosures and Net Media Center Combo Kits
- Available in 20 pack

OPTIONAL ACCESSORIES

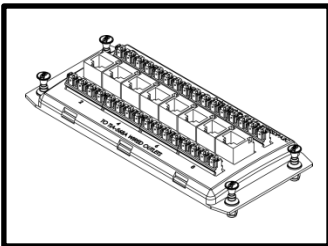

Data Modules

ICRESDPx*3D PCB 10-Pack
 ICRESDPx*3C PCB Board
 ICRESDPx*2C Plastic Cover
 ICRESDPx*1C Steel Cover

- 8 Ports, 110-Type IDC
- Supports up to 8 computers

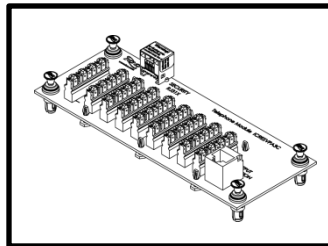

Voice Modules

ICRESVPA3D PCB 10-Pack
 ICRESVPA3C PCB Board
 ICRESVPA2C Plastic Cover
 ICRESVPA1C Steel Cover

- 8 Ports, bridged IDC
- Built-in RJ-31X and expansion port

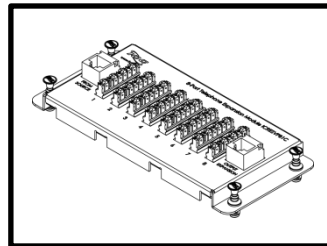

Expansion Module

ICRESVPB3C PCB 10-Pack
 ICRESVPB2C Plastic Cover
 ICRESVPB1C Steel Cover

- 8 Ports, bridged IDC
- Built-in RJ-31X and expansion port

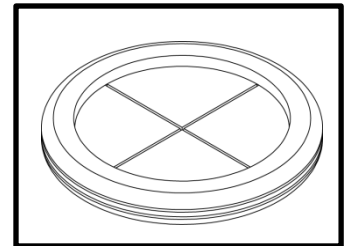

Grommet

ICRSDCAC2 10-pack

x*: B(CAT 6), A(CAT 5e)

888-ASK-4ICC

csr@icc.com

icc.com